

# Angular Contact Ball Bearings

Bearing No. : **NACHI 7302BDF**

■ Bearing Type

■ Clearance

■ Tolerance Class

### Dimensions

d = 15<sup>0</sup><sub>-0.008</sub>  
 D = 42<sup>0</sup><sub>-0.011</sub>  
 B = 13<sup>0</sup><sub>0.000</sub>  
 r = 1~1.5  
 (Radial Direction)  
 r = 1~3  
 (Axial Direction)  
 r1 = 0.6~1  
 (Radial Direction)  
 r1 = 0.6~2  
 (Axial Direction)  
 a = 5.5

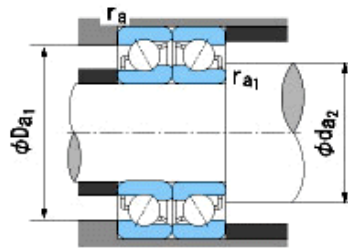
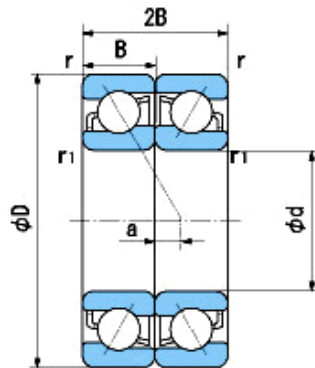

### Dimensions

da1(min) = 21  
 da2(min) = 18  
 Da1(max) = 36  
 Da2(max) = 38.4  
 ra(max) = 1  
 ra1(max) = 0.6  
 Mass = 0.17 kg

Basic Dynamic Load Rating Cr :	<b>21,000</b> N
Basic Static Load Rating Cor :	<b>13,500</b> N
Limiting Speed ;	
Grease Lubrication :	<b>11,000</b> min <sup>-1</sup>
Oil Lubrication :	<b>16,000</b> min <sup>-1</sup>

	INNER RING	OUTER RING
O.D.Surface Runout with Side :		-
Axial Runout with Bore :	-	
Axial Runout with Raceway :	-	
Width Variation :	<b>0.020</b>	<b>0.020</b>
Radial Runout :	<b>0.010</b>	<b>0.020</b>